

# PulseEight

## Dynamic Downhole Reservoir Management System



### Applications:

Pressure & temperature profiling

Interval control

Ambient valve replacement

Multi-lateral control

Autonomous gas-lift optimisation

Water and gas shut-off

Formation integrity

Gas hydrate prevention

Crossflow prevention

PulseEight systems employ Fluid Harmonics production telemetry that puts produced fluids to work as a two-way channel for data and tool commands. It's the next wave in completions intelligence.

# Pressure & Temperature Profiling

Downhole pressure & temperature data can provide great value to operators across a range of applications: from maintaining flowing bottom hole pressure within set boundaries to avoid excessive draw down or producing below the bubble point, to monitoring the efficiency of injection methods and the effect on bottom hole pressure.

Many mature wells have no active Pressure and Temperature (PT) measuring system, possibly because the technology was not available or cost-effective at the time of completion, or the downhole equipment has failed and a workover is not possible. Traditionally the only alternative is to run short-term memory gauges each time a pressure survey is required. This comes with the additional costs, deferred production and risk associated with the required intervention, but also does not provide any real-time data to help understand reservoir dynamics and improve decision-making/recovery techniques. Tendeka's PulseEight Wireless Gauge can be installed in the production tubing and configured to send pressure and temperature data to surface, providing real-time information without the need for a workover.

The system can be deployed in the well via conventional intervention techniques and mounted below a lock mandrel or plug, allowing it to be positioned in a nipple profile or tubing joint. Once set in place, the PulseEight system can send back pressure and temperature information via its unique Fluid Harmonics telemetry system. Typical data rate for PT telegrams is 1 per day, however higher rates may be possible depending upon the well specifics. Fluid Harmonics signal generation is based on the ability of the Wireless Gauge to recognise and create a defined pressure

drop across itself which minimises the impact of fluctuations in flowing conditions. The system can also record high resolution data (up to 1 second) to memory should this need to be reviewed after the gauge is recovered to surface for battery change-out. However, should data rates require to be changed whilst the tool is in hole, the tool can be reconfigured by sending coded pulses from surface without the need to retrieve and reprogram.

Full ICV systems can also be offered which provide downhole shut-in capability such that pressure build-up/drop-off tests can be conducted without the effects of wellbore storage having to be considered. In these cases, the device can autonomously change its data logging rate during shut-in to yield higher resolution for pressure transient analysis.

## Benefits

- Improved reservoir understanding leading to informed decision-making
- Enhanced well performance
- Reduced intervention/workover requirements
- Reconfigurable data rates whilst in hole

## Pressure & temperature profiling

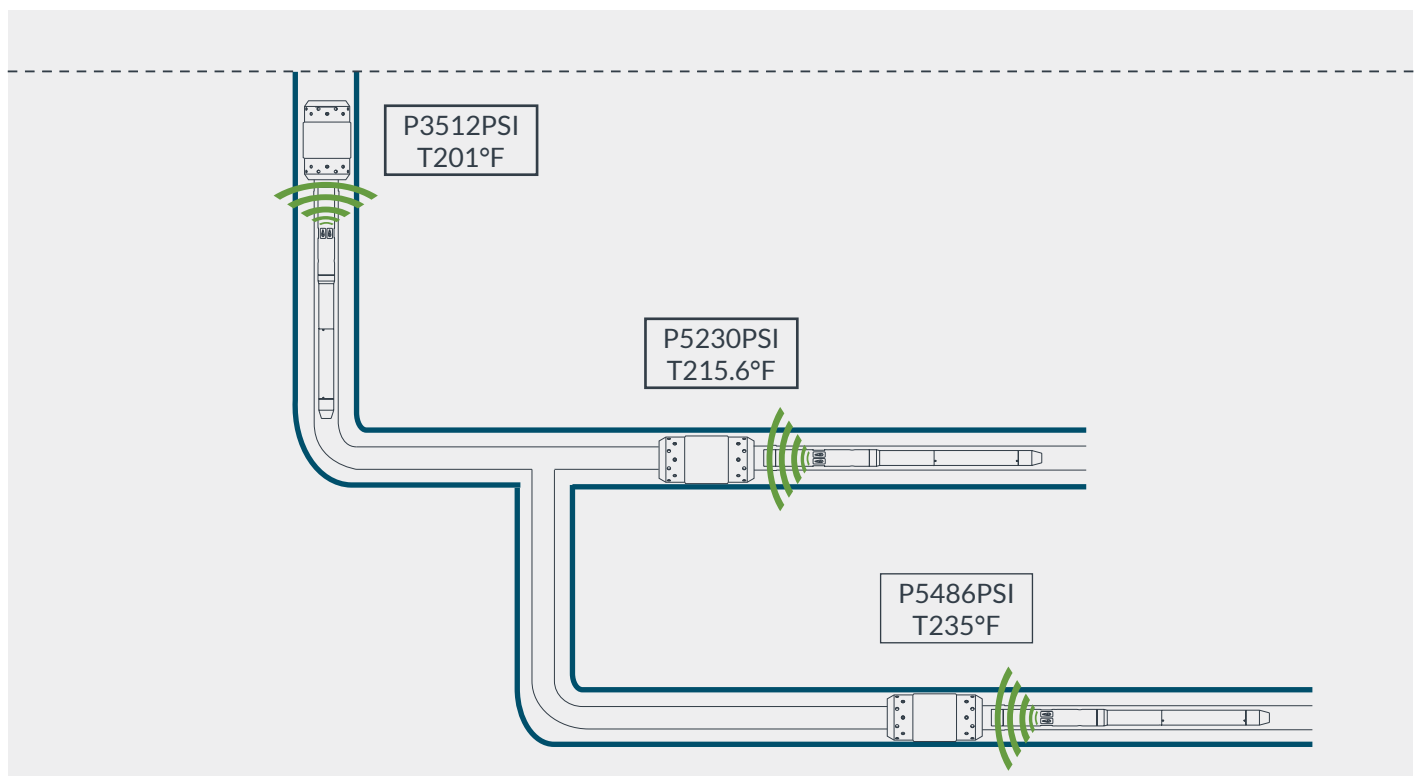

# Interval Control

A variety of flow control valves are available on the market with the aim of modifying the injection or production profile to improve recovery factors and create optimal production conditions. PulseEight Intelligent Control Valves (ICV) offer these same benefits, but in a wireless and truly intelligent format.

The PulseEight wireless communication methodology enables communication to multiple tools within the same wellbore which gives the same level of multi-zonal control as conventional smart well completion methods. The PulseEight ICV range has infinitely variable position chokes which provides a seamless level of control across each device to create an optimal inflow profile for an entire wellbore.

With built-in intelligence, PulseEight ICVs are able to react to downhole parameter changes to maintain a target pressure drop without operator intervention. This provides immediate adjustment to the inflow profile, removing the time-consuming, manual decision-making loop which can prolong sub-optimal performance. Alternatively a fixed choke position can be selected as a more conventional means of control.

The versatility of the retrofit design of PulseEight ICV means this can be efficiently applied to existing wellbores to control unexpected water breakthrough and isolate problematic zones until water encroachment has fallen back or minimise crossflow potential from differently pressured zones.

## Benefits

- Increase total oil production with minimum water cut
- Autonomously manage mass flow through device
- Control the production from various zones, as well parameters change
- Significantly less complex than cabled systems
- No control lines
- No limit on depth
- Increased ability to locate device at required inflow zone

## Interval control

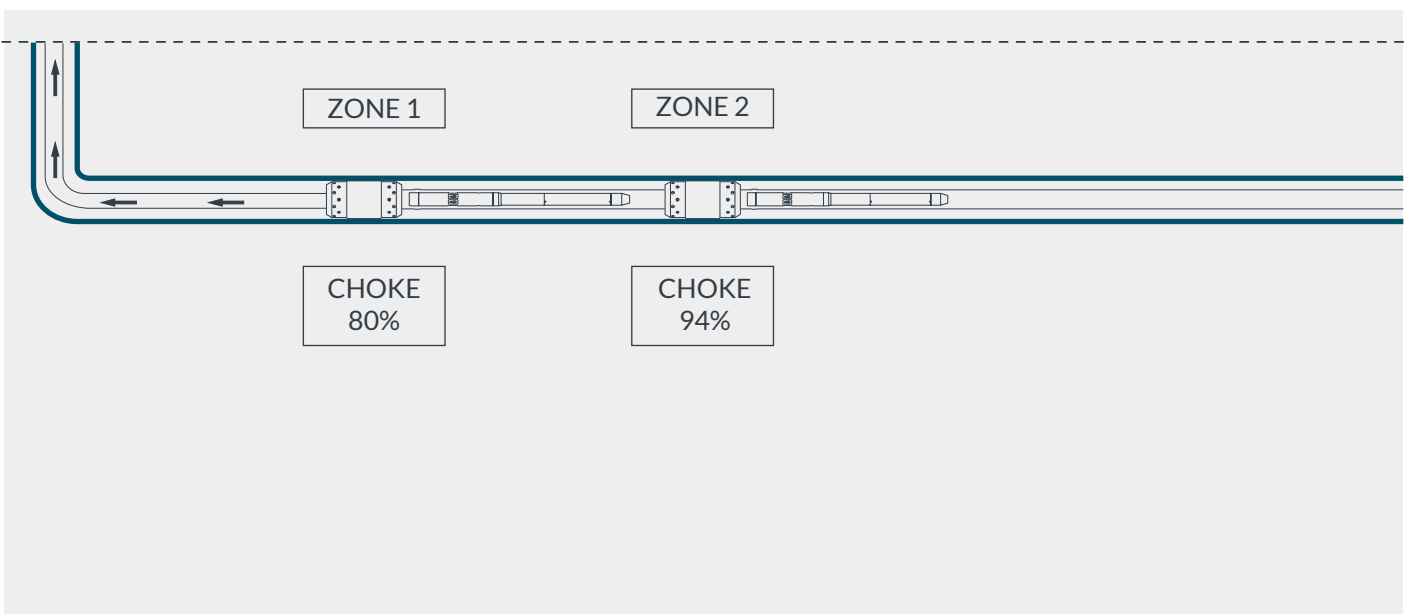

# Ambient Valve Replacement

**PulseEight Ambient Valve** can offer a robust alternative to storm chokes when control line failures prevent the use of traditional insert valves. Downhole intelligence, simple installation and set-up can remove the limitations associated with more traditional methodologies, ensuring production can be maintained whilst awaiting for a workover.

In situations where a well has a failed safety valve, insert valves are typically run to regain control. These permit the well to be returned to production and can be controlled in an identical manner to the original system. However, if the failure mode of the existing safety valve is in the control line, it generally prevents the use of these traditional insert valves. Limited further options exist for remediation and in most cases an ambient valve (storm choke) is used.

Storm chokes present restricted functionality based on the need to set a nitrogen dome pressure derived from the current flowing conditions. However, the fickle nature of these parameters results in the need for constant testing to ensure that the preset values are still suitable for natural changes in flowing conditions.

The PulseEight Ambient Valve helps remove many of the limitations of existing systems by having the tool autonomously react to the changes in the flowing conditions associated with both a loss of containment but also emergency shut-down events. The system can be deployed in the well via conventional intervention techniques and mounted below a lock mandrel or plug, allowing it to be positioned in a nipple profile or tubing joint around existing safety valve depth. As part of the commissioning phase, actuation of the valve from surface can allow the system to functioned closed to permit inflow testing prior to being returned to full operational mode.

The system is designed to send a vitality pulse on a daily basis confirming that the tool is still operational, helping to minimise the testing regimes typically undertaken with conventional systems. Battery usage monitoring can allow the timely scheduling of interventions required for battery change out, but also utilise the incorporation of a “make safe” functionality whereby the tool can function closed prior to full battery depletion.

## Ambient valve replacement

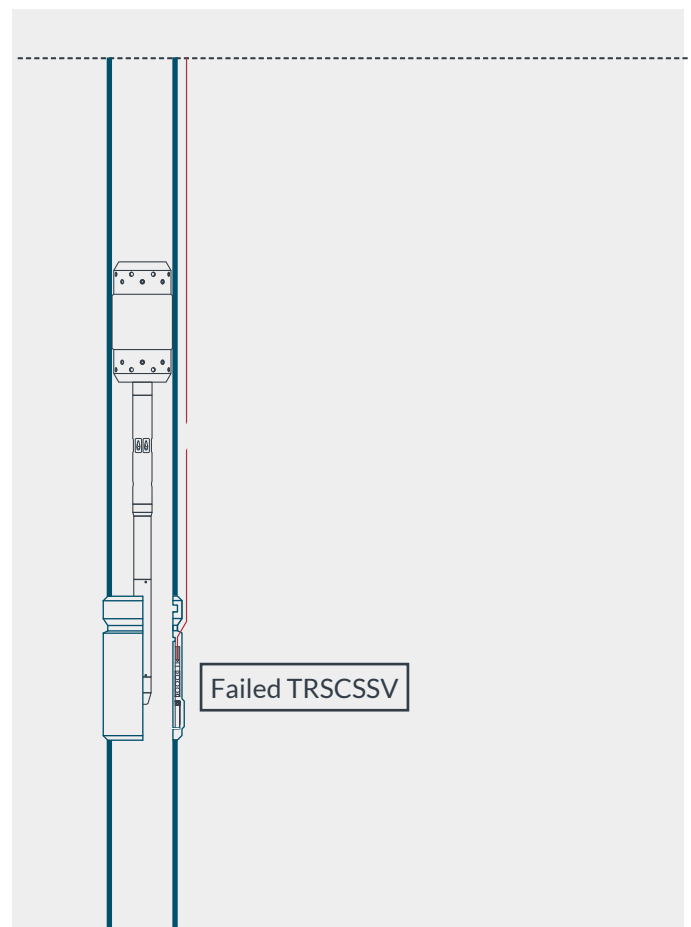

# Multi-Lateral Control

Adequate control of flow from independent legs of multi-lateral wells is complex but necessary for the optimisation of these well designs. PulseEight Intelligent Control Valves (ICV) offer individual bore or zonal control, without the need of cables of control lines.

Multi-lateral technology has been developed to improve reservoir exposure from a single bore, significantly reducing field development costs. Intelligent completion flow control technology has traditionally been used in the mother-bore of these wells to manage lateral production. However due to the hydraulic and electric control lines required, this has been limited to dual lateral wells as it has not been possible to place control valves within individual laterals. As technology used for well construction has improved, tri and quad laterals are becoming more common, but the architecture of these wells makes the required level of flow control difficult to achieve by conventional means due to the required control lines and complex junction structures.

Tendeka's PulseEight ICV provides flow control without the requirement for downhole cables and wet connects, making them compatible with complex junction structures and aiding deployment methods by allowing rotation of the string during deployment process. PulseEight ICVs offer the facility to be installed at the top of each lateral branch and run as part of the lower completion, with the ability to act as a fluid control device during deployment.

Options for opening can be as simple as functioning on a pre-set timer (sequentially for clean up, or all at once), or by individual surface command. Each choke position achieved can be configurable based on pre-programmed parameters or by addressing each, or all tools from surface. After the well is

producing, having the device installed at the top of each branch allows production rotation of each lateral to determine individual contribution and balance the overall inflow from multiple branches. This is easily achieved with fluid harmonics.

PulseEight can also be used for individual zonal control within the lateral itself. Each valve can be discretely controlled to manage water/gas coning and balance the inflow profile. It can also be used in well stimulation regimes to target specific zones and manage the injection profile.

## Benefits

- Determine contribution of each lateral
- Cycle lateral production to manage performance
- Produce separately for improved clean up
- Reduce installation time

## Multi-lateral control

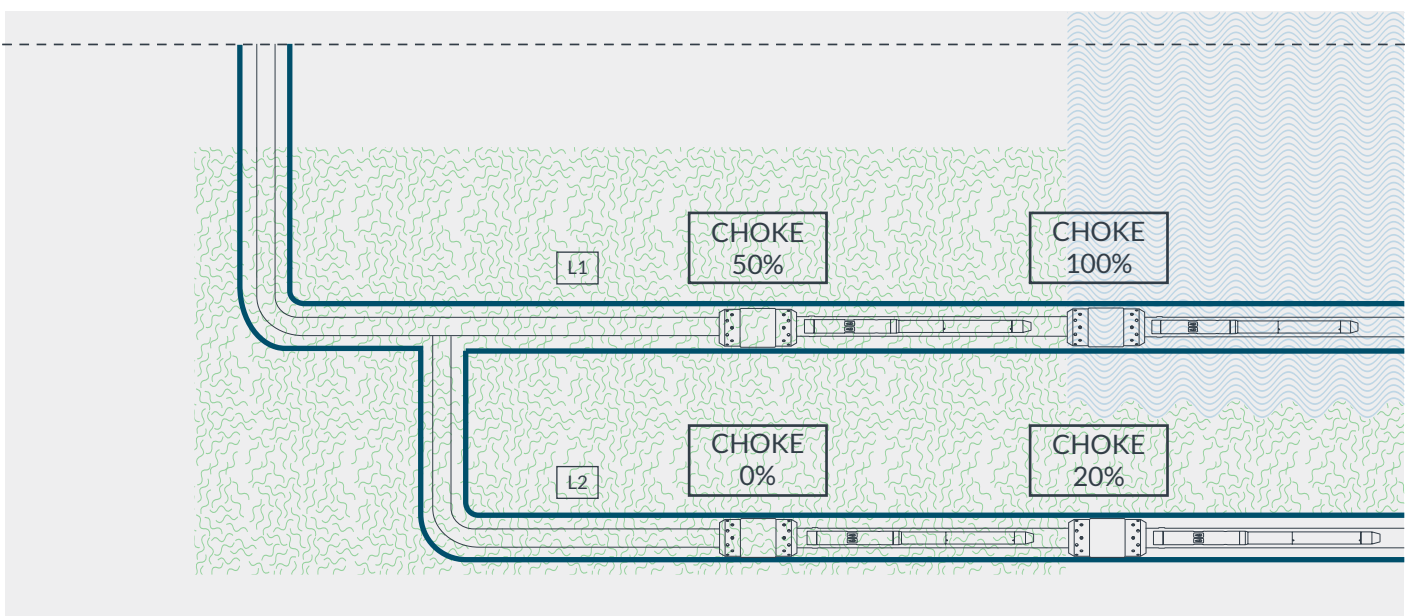

# Autonomous Gas Lift Optimisation

The PulseEight Intelligent Control Valve (ICV) range can optimise inflow performance by effectively controlling the contribution gas bearing intervals, or existing gas caps, to maximise the productivity of oil bearing zones.

By placing a PulseEight multi-zonal ICV device across a gas producing zone, it can be used to regulate the inflow of gas to aid lifting of a lower producing oil zone. The device can autonomously regulate the gas inflow to a set rate or be instructed to modify based on surface commands.

To use this technique with traditional equipment would result in relying on accepting the additional gas required for start-up during long-term, steady-state production. PulseEight ICVs can offer the ability to select the optimum gas contribution at any time through the well life.

Tendeka's PulseEight system is compatible with existing wells and can be retrofitted into place on a single intervention run. This provides a simple solution for wells which were initially producing unassisted but have suffered from declining reservoir pressure. This gives the ability to gain the benefits of gas lifted wells in locations where traditional gas lift cannot be used, or eliminate the need pump mechanisms traditionally used in declining pressured reservoirs.

The same principles can be used for liquid unloading in underperforming wells, giving the opportunity to unload then isolate the gas zone as required.

## Benefits

- Autonomous regulation
- Re-programmable as well conditions change
- Reduced intervention

## Autonomous gas lift optimisation

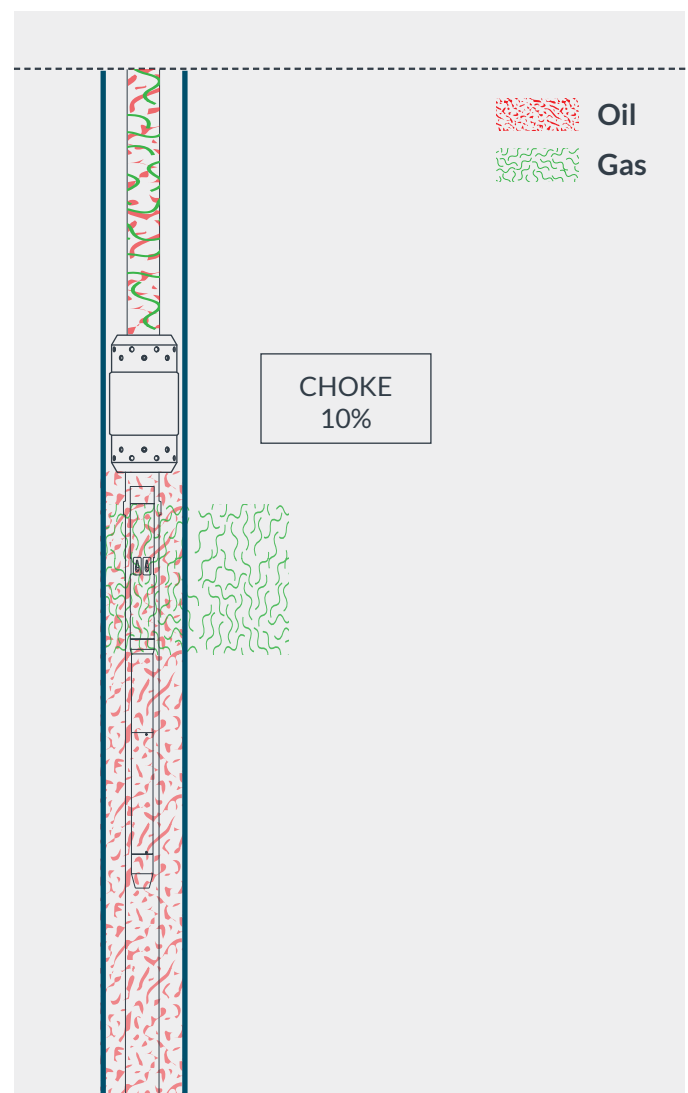

# Water & Gas Shut Off

Tendeka's PulseEight Intelligent Control Valve (ICV) offers the ability to selectively isolate zones with undesirable liquids or gas throughout the life of the well with the option to recombine flow at a later date without the need of intervention.

In oil producing wells with separate reservoir layers, water and gas breakthrough can occur at various stages across the production life cycle. This surge in water/gas production can significantly increase OPEX due to the surface processing required. Thus, some wells are often isolated with oil left in place, or have production deferred due to the surface handling costs.

Solutions to increase recovery by producing the low water cut (WC)/GOR zones harder can often be counter-intuitive as it leads to an increase in coning on the problematic zone and causes the zone to water out faster.

Tendeka's PulseEight ICV can be remotely activated via fluid harmonics to isolate the high WC/GOR zones, allowing the remaining zones to be produced more efficiently, and negate the need for complete shut-in of the well leading to deferred production. In instances where the water/gas is assumed to have fallen back, the zone can easily be re-opened to help maximise recovery.

## Benefits

- Suitable for existing wells
- Rapid control of high WC/GOR zones
- Reduced surface handling costs
- No deferred production
- Reduced intervention

## Water & gas shut off

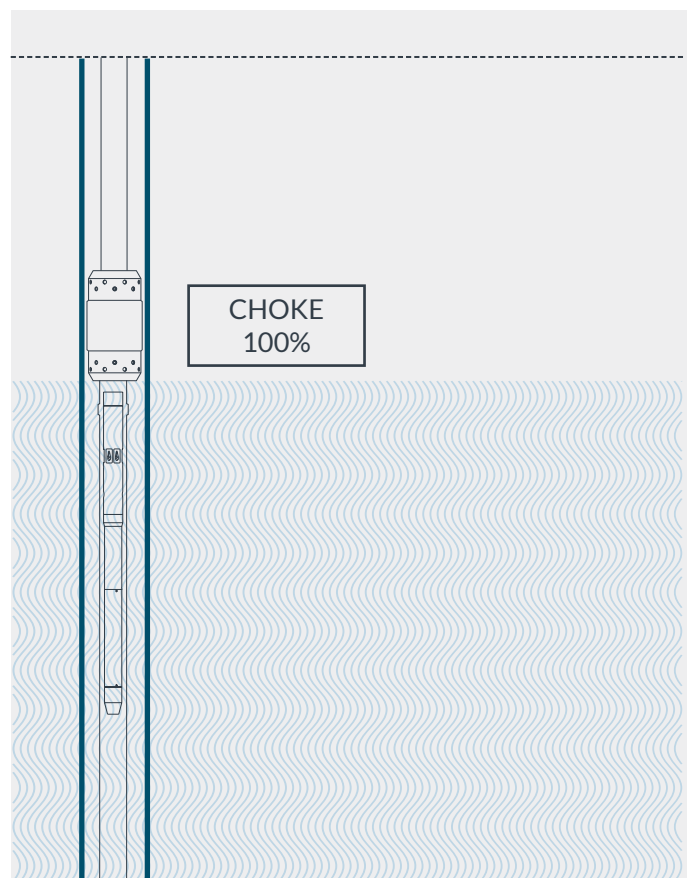

# Formation Integrity

The potential for sand failure in weakly consolidated formations is most prevalent through **well start-up**. PulseEight Intelligent Control Valves (ICV) can control the pressure differential seen by the formation to ensure production can be brought online safely and efficiently without risk of damage to the formation.

Specific “bean up” procedures are required to bring sand prone reservoirs online and are typically adequately controlled during initial start-up. However, the potential that these procedures may be missed upon start-up of multi-well assets, post shut-down, have the potential to irreversibly impair the production potential of those wells.

The PulseEight ICV incorporates an infinitely variable downhole choke, with the ability to measure both upstream and downstream pressures. These attributes, coupled with the intelligence built into the tool, results in PulseEight being able to recognise a well shut-ins and conduct an automatic staged reopening that does not risk damage to the formation.

Upon well shut-in, the PulseEight intelligent choke will move to a preset start-up position. Upon indication of the well being opened up at surface, the tool will only allow an appropriate pressure differential across itself in line with the prescribed bean up procedure. Each time dependent stage will be carried out downhole until the well is back at full production rate. This will be carried out autonomously by the tool regardless of the surface choke position.

## Benefits

- Mitigates the risk of formation sand failure
- Limits the potential of sand screen plugging
- Limits the potential of wellbore fill
- May improve asset start-up times with well flow controlled automatically

## Formation integrity

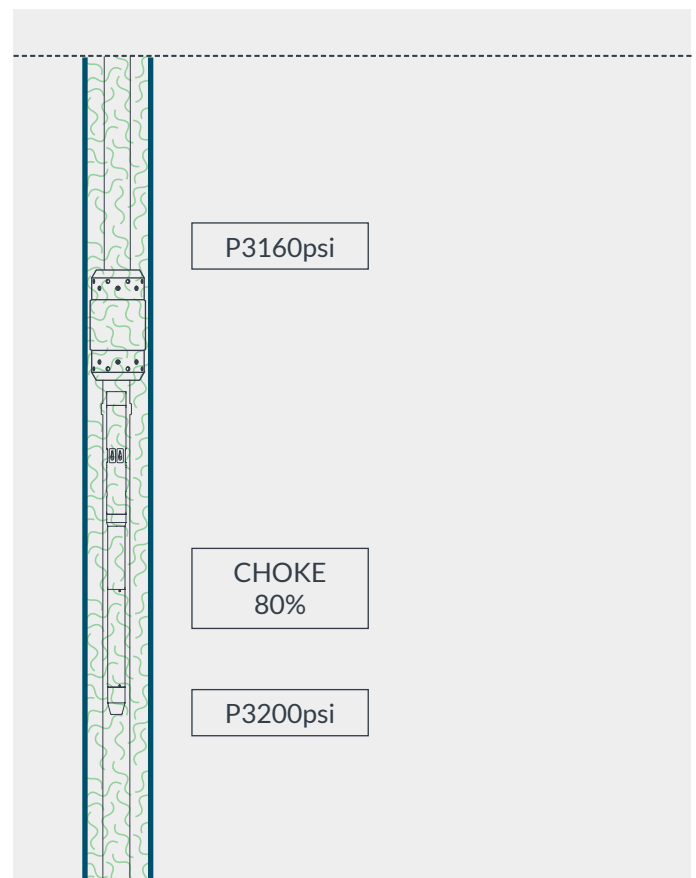



# Gas Hydrate Prevention

Gas hydrates can begin to form across the surface choke, or any restriction, when certain temperature and pressure differential conditions are met. This thermodynamic condition is caused by the throttling process known as the Joule-Thompson cooling effect.

This is most commonly seen in new dry gas wells that require a significant pressure drop at surface to meet a much lower pipeline pressure. Surface mitigation of this effect usually requires costly surface heaters and injection of chemical inhibitors, both expensive solutions requiring facilities modification.

Mitigation can be more simply achieved by moving the point of pressure and temperature reduction downhole where the Joule-Thompson cooling response is geothermally regulated. By positioning a PulseEight ICV downhole, the incorporation of an infinitely variable downhole choke with downstream pressure gauge provides this capability.

The tool is programmed to target a fixed downstream pressure, which means PulseEight ICV can actively respond to changes in well conditions and adjust to maintain the optimum flowing environment. As well pressure declines, and the requirement for choking diminishes, the choke will move to a fully open position and can ultimately be retrieved from the well, when convenient, for redeployment elsewhere.

Deploying PulseEight as an automated choke can minimise the risks associated with hydrate formation at or near surface pipework. It can also help maintain optimum productivity throughout the well lifecycle.

## Benefits

- Eliminate requirements for surface heaters and chemical injection
- Continuously optimise the well performance
- Mitigate well performance uncertainty
- Mitigate choke erosion
- Reduce the requirement for well intervention

## Gas hydrate prevention

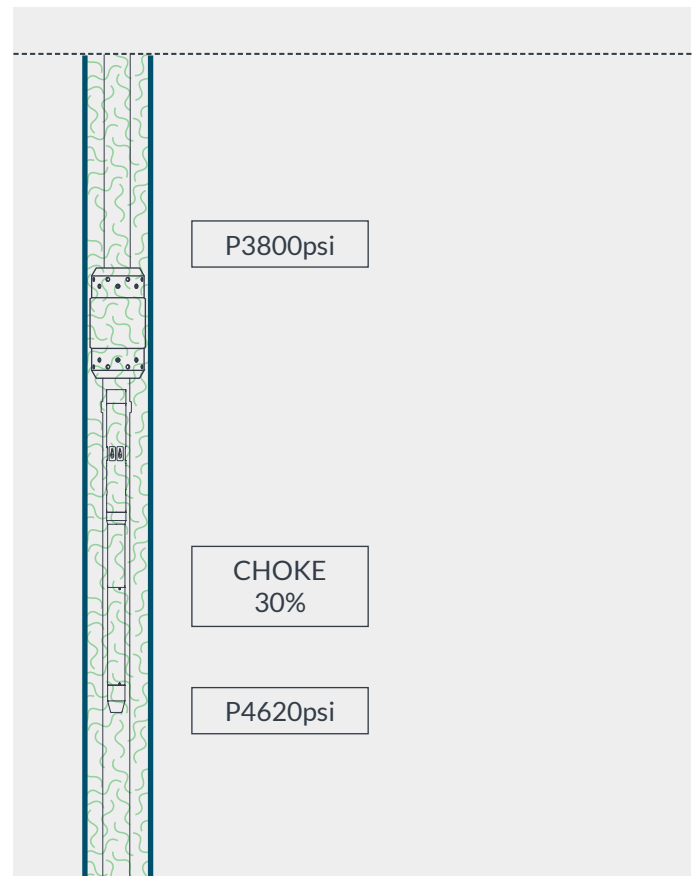

# Crossflow Prevention

Tendeka's PulseEight Intelligent Control Valve (ICV) range is the latest advance in wireless well completion technology. By using unique Fluid Harmonics Telemetry, PulseEight ICVs communicates wirelessly between downhole and the wellhead.

Crossflow is a condition that occurs in multi-layer reservoirs with compartmentalised wells, whereby flow from the high-pressure zone migrates into the low-pressure zone rather than up the production tubing to surface. Pressure data from each flowing zone can be used to better understand the flow from each zone. Conventional systems require topside analysis and decisions to then determine the changes required downhole.

PulseEight is able to monitor the inflow and outflow pressures at each device and adapt to suit autonomously. PulseEight is also able to detect reverse flow and adapt its choke setting to mitigate.

## Benefits

- Autonomous inflow monitoring, communication to surface of data
- Autonomous inflow control, regulate flowrate to prevent crossflow
- Re-settable values from surface as required

## Crossflow prevention

